



CHERKASY
Investment passport
2023

Why Cherkasy

Cherkasy is a powerful industrial city, conveniently located on the bank of the largest water reservoir of the country, - the Dnipro River, in the very heart of Ukraine.

Cherkasy is the regional center of Cherkasy oblast', which is known for its high level of development of agro-industrial complex.

Cherkasy is a city located at the intersection of the main transport routes of the country, namely, road, water and rail routes.

Cherkasy is the logistics center of the region, a river port, airport, railway passenger and freight stations, electric and road transport operate here.

Cherkasy is a city known for its natural and recreational resources, numerous parks, gardens, beaches, architectural landmarks.

Cherkasy is a cultural and educational center, a city of talented youth and event tourism

Background information

Area of the city	7.8 ths ha
Area under construction	6.0 ths ha
Time zone	UTC +2
Climate	moderate continental
Population	269.8 ths
Number of employed	76.9 ths
Average monthly wage	₴ 14758 / € 378
Leading industries	Chemical, woodworking, food, machinery, trade, construction
Number of enterprises	> 4.4 ths
Number of entrepreneurs	> 16.1 ths
Industry volume in 2021	₴ 34.8 bln / € 1128.5 mln
Capital investments in 01.01.2022	₴ 4556.0 mln / € 147.3 mln
FDI on 01.01.2020	€ 91.7 mln



Diploma of the Council of Europe
Flag of Honour of the Council of Europe



High investment attractiveness in "IBI-Rating" ratings

uaA-

High creditworthiness in "IBI-Rating" ratings

Focus

Sixth place in the ranking of the most comfortable cities in Ukraine according to Focus in October 2021

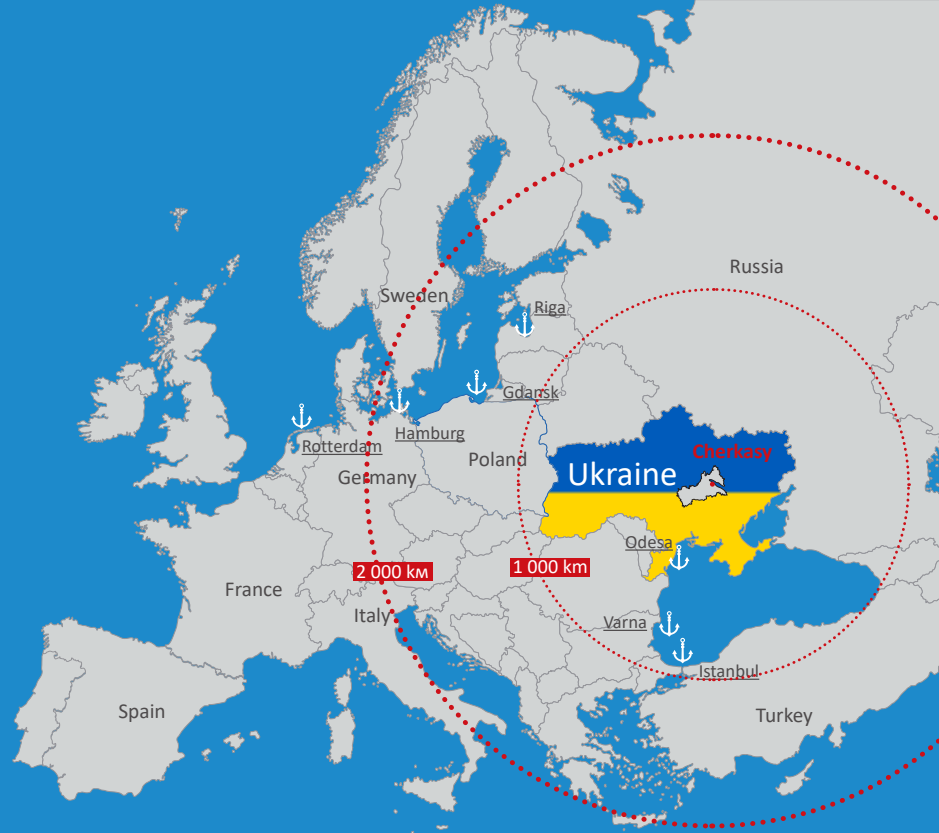

Cherkasy has been known since the XIII century and during its existence it has played a significant role in the history of the entire Ukraine.

Cherkasy was the center of the formation of the Cossack state, the residents of the city participated directly in Khmelnytskyi and Koliyivshchyna liberation uprisings.

Cherkasy is located on the right bank of the Kremenchuck reservoir, the largest water reservoir in the country, created in the middle flow of the Dnipro River. The Kremenchuck reservoir is 185 km long.

Cherkasy received the Magdeburg Law of the city in 1791.

Since receiving the status of the oblast' center, **Cherkasy** has turned into a large industrial center and the main cultural center of the region

Cherkasy is divided into two urban districts, namely, Prydniprovsky and Sosnivsky, the latter including the village of Orshanets.



Quality of life and safety



City in ratings

City safety rating

Cherkasy is among the TOP-10 cities in the ranking of the most comfortable cities in Ukraine according to the publication "Focus". Among the criteria by which cities were evaluated: economic indicators, the availability of rating schools, the quality of municipal services, the state of the environment, life expectancy.

City	Rating
Ternopil	84,7
I-Frankivsk	81,3
Khmelnyskyi	80,1
Vinnysia	78,8
Rivne	78,3
Cherkasy	77,3
Kyiv	74,6

Quality satisfaction rating of areas and services

According to the results of the Eighth Municipal Survey prepared by the sociological group "Rating" Cherkasy is among the TOP-10 cities by the index of satisfaction with the quality of areas and services, which is based on the results of the population survey on the quality and development of infrastructure, accessibility of various services, the state of the transport system, trade, social, cultural and sports areas, police activity, environment.

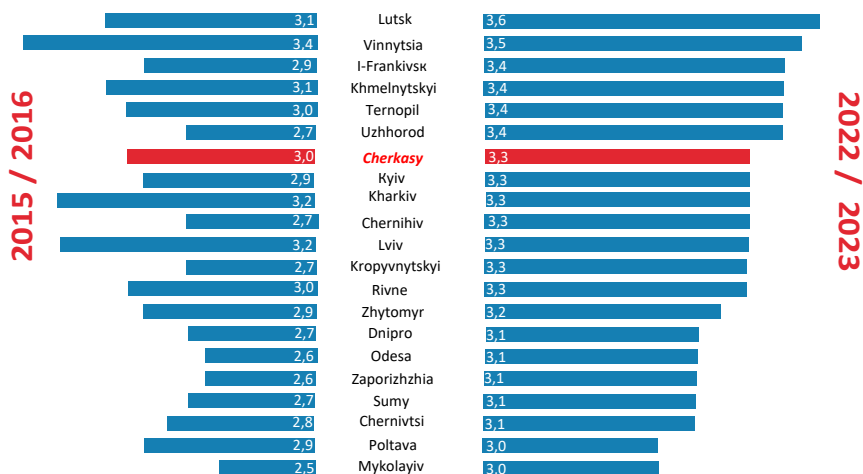

Cherkasy is known for its parks and gardens, as the area of green space is 2.1 ths ha accounting for 31% of the city area.

There are 32 objects of the nature reserve fund of an of 203.2 ha.



The state of the environment in Cherkasy is characterized as stable.

The pollution index corresponds to the national average indicator.

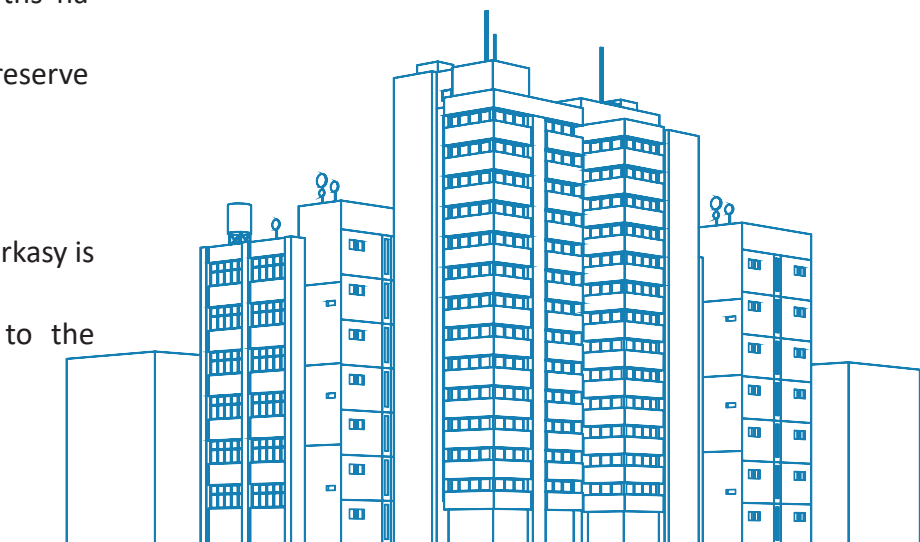

Leisure and sports

Cherkasy is a significant cultural and educational center, there are theaters, regional philharmonic, cinemas, numerous museums and cultural institutions in the city.

Cherkasy is one of the few cities in Ukraine to have its own planetarium.

For many years **Cherkasy** has been known for holding numerous festivals, including music festivals, such as «Through thorns to the stars», jazz and rock music festivals «Cherkasy jazz days», all-Ukrainian competition for young jazz singers «Jazz Palette».

The following festivals have become traditional: «Power of Borsch», «Cherkas'ka Maslyana», «Ivan and Marichka», «Cherkas'ka Smakota», «Zelen-fest», «Baby Boom», Night on the Eve of Ivan Kupala, Trypillian stars.

In 2018, on the occasion of Street Music Day, an aerial sculpture of a girl-violinist, «High note», was installed. The sculpture is among the TOP-10 most impressive sculptures, the illusions of the world.

Cherkasy is a sports city known for its athletes, Olympic champions and winners of prestigious sports competitions.

There are 8 sports schools where young athletes are trained in more than 30 sports.

Every year more than 200 sports events are held in the city.

The main sports facilities of the city are the Sports Complex «Budivel'nyk» and the Central City Stadium - a multipurpose stadium with a capacity of 10.3 ths spectators.

Cherkasy Cruising Yacht Club «Parus» is the second in Ukraine by the number of sports vessels.

«Cherkasy monkeys» is the city's most famous sports club, which in 2018 earned the title of Champion of Ukraine in Basketball.



8

monuments of architecture



22

archeology monuments



23

landmarks of monumental art



22

historical landmarks

2

stadiums

3

fitness centers

37

gyms

72

sport facilities gym

142

sports grounds

4

swimming pools

18

shooting ranges

50

other sports facilities

Innovation in management

Cherkasy is among the TOP-10 cities in terms of satisfaction with the activities of the city authorities, compiled based on the results of a social survey by the sociological group "Rating" in 2023.

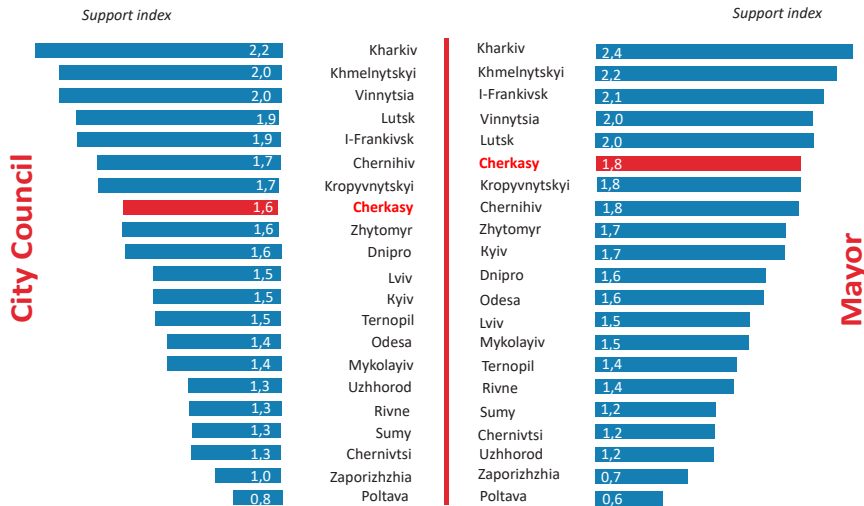

Cherkasy took 18th place among 38 cities of Ukraine in the ranking of Forbes "The best cities for doing business" in 2021.



Among the cities in the section "Purchasing power".



Among the cities in the "Business Activity" section.



In 2023, **Cherkasy National University** ranked 20th among Ukrainian universities in terms of the prestigious global Scopus database.



By implementing best practices of transparency, openness and accountability of local self-government, the «Transparent Councils» coalition

members have recognized **Cherkasy City Council** as the most progressive.



Cherkasy City Council was awarded «Media-friendly Council 2017» award, which was obtained based on

results of a survey conducted by Mass Media Institute with the support of «Freedom House».



Since 2015, the public budget has been in operation. **Cherkasy** residents can submit project proposals, support them and monitor the implementation of the winning projects.



Cherkasy joined the system of electronic public procurement.



Since 2016, a form of collective appeal of residents to the city authorities has been operating in **Cherkasy** to collect signatures in support of an e-petition on any matter within the competence of the authorities.



Labour market and education



Labour market

Cherkasy has a significant labour potential.

The share of the working-age population is higher than Ukraine's average indicator.

By gender, the majority of the population are women.

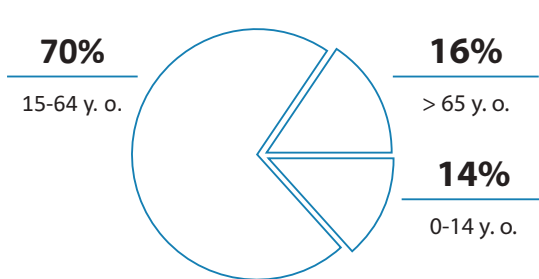

Structure of population by age

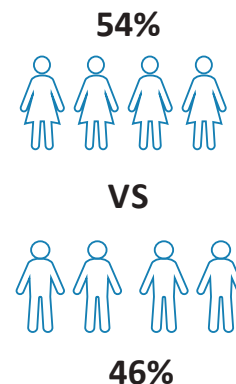

Main indicators of labour market

Indicator	2021	2022
Employed	83.1 ths	76.9 ths
Number of unemployed (o.e.y.)	1.9 ths	1.0 ths
Employed	2.4 ths	1.7 ths
Number of vacancy (o.e.y.)	383	237
Workload for a vacant position	5	4
Average monthly wage	₴11905/ € 385	₴14758/ € 378

Vacancies by wage

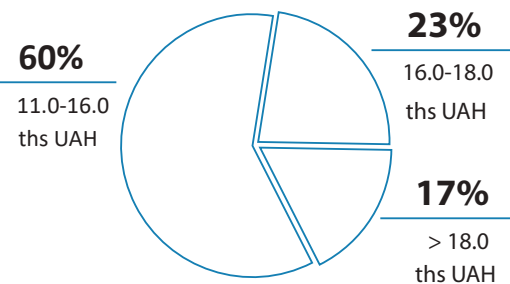

The available labour potential given relatively low wages in **Cherkasy**, create additional advantages for investors in terms of starting up and doing business in the city.

Vacancies by type of economic activity

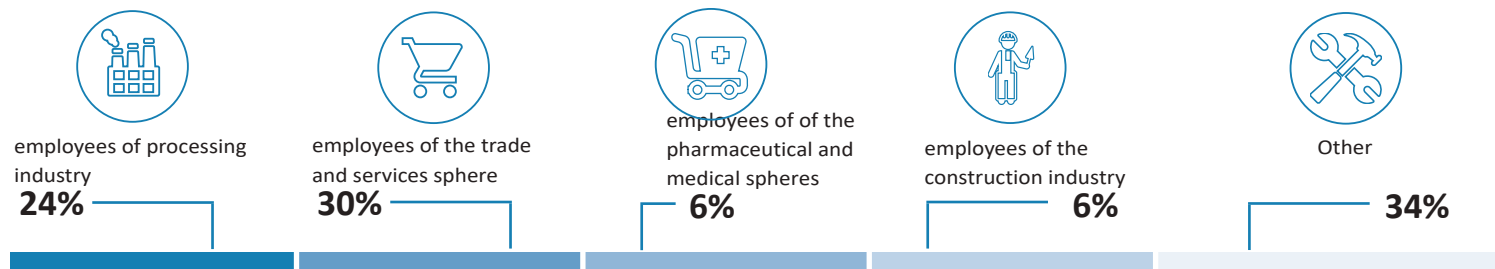

Education

Cherkasy's competitive advantage is human capital and a large number of talented youth.

Education in the city today is a stable, positive development system with significant potential. In terms of its size and branching, it is rather well aligned with quantitative indicators of the city's population and their needs in educational services.

Pre-school education

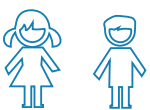

53	8083	2 263
number of children's educational institutions	number of children	number of staff

Preschool, school and extra-curricular education is a major priority of *Cherkasy* development.

Educational institutions are equipped with appropriate equipment, and qualified personnel are employed here.

School education



41	28722	3470
number of schools	number of pupils	number of staff

Out-of-school education



11	9545	704
music and art schools	number of pupils	number of staff

Availability in *Cherkasy* of a system of extracurricular institutions with a multidisciplinary and specialized form of education.

The extensive system of placement of out-of-school institutions on the territory of the city makes it possible to reach a large number of pupils.

Out-of-school education



8	3454	83
sport schools	number of pupils	number of staff

Professional education

Cherkasy city educational institutions train students in many majors and different educational programs.

All educational institutions are open for cooperation with business in terms of gaining practical knowledge of students.

Vocational and higher education is represented by an extensive system of educational institutions which provide education for professionals in different professions.

There are ample opportunities for business to develop joint training programs with vocational schools for the targeted training of the necessary qualifications and technical professions.

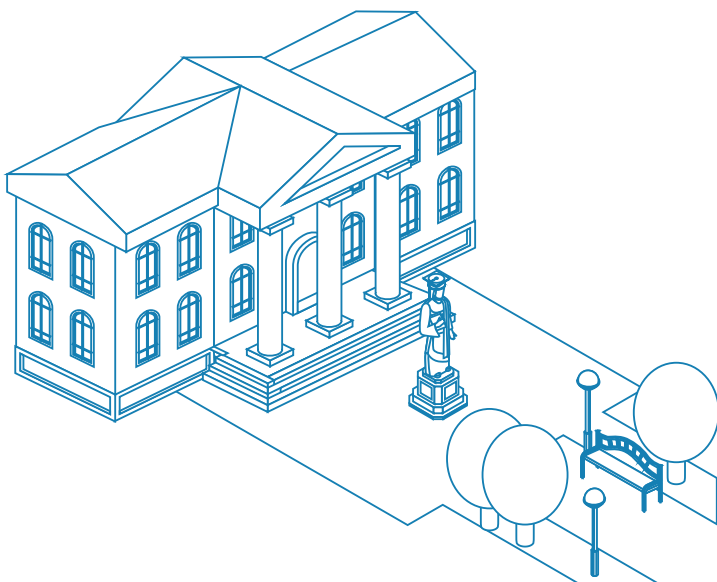

6

number of educational institutions

>14.5 ths

number of students

>1.0 ths

number of lecturers



4

number state institutions vocational education

>2.1 ths

number of students

leading educational institutions



Cherkasy National University named after Bohdan Khmelnytsky

Founded in: 1921. Faculties: Psychology, Computer Technology, Intellectual and Management Systems. Educational - scientific institutes: Economics and Law, Foreign Languages, History and Philosophy, Pedagogical Education, Social Work and Art, Natural Sciences, Ukrainian Philology and Social Communications, Physics, Mathematics and Computer-Information systems, Physical Culture, Sports and Health.



Cherkasy State Technological University

Founded in: 1960. Faculties: Construction, IT- Technologies, Machine Building and Design, Electronic Technologies, Food Technology and Service Industry, Economics and Management, Information Technology and Systems, Linguistics.



East European University

Founded in: 1992. Faculties: Institute of Business Management, Institute of Law, Institute of Economics, Institute of Management.



Cherkasy Educational and Scientific Department of Ivan Franko Lviv National University

Founded in: 1968. Faculties: Management and Law, Department of Finance and Banking, Accounting and Taxation, Law and Social and Human Sciences.



Cherkasy Institute of Fire Safety

Founded in: 1973. The Institute trains specialists for the SES of Ukraine in the specialty "Fire Safety", areas "Psychology", "Systems Engineering", "Automation and computer-integrated technologies", "Civil Protection" and other specializations.



Cherkasy Medical Academy

Founded in: 1930. The Academy trains junior specialists in nursing, medical, obstetrics and prevention, laboratory diagnostics, orthopedic dentistry and pharmacy, as well as bachelors in nursing and pharmacy.



Transport connection



Inter-city connection

Cherkasy is a transport hub of Ukraine and has a real prospect of becoming a large logistics center.

The city is located in the center of the country at the intersection of the main transport routes of the state, such as: water, automobile, railway and air routes.

In **Cherkasy** air, railway, automobile, electric and water types of transport operate

Railway connection in Cherkasy

Connection	Distance	Train time
Cherkasy - Kyiv	189 km	03 : 07
Cherkasy - Ivano-Frankivsk	717 km	16 : 29
Cherkasy-Odesa	445 km	11 : 16
Cherkasy - Lviv	727 km	12 : 19

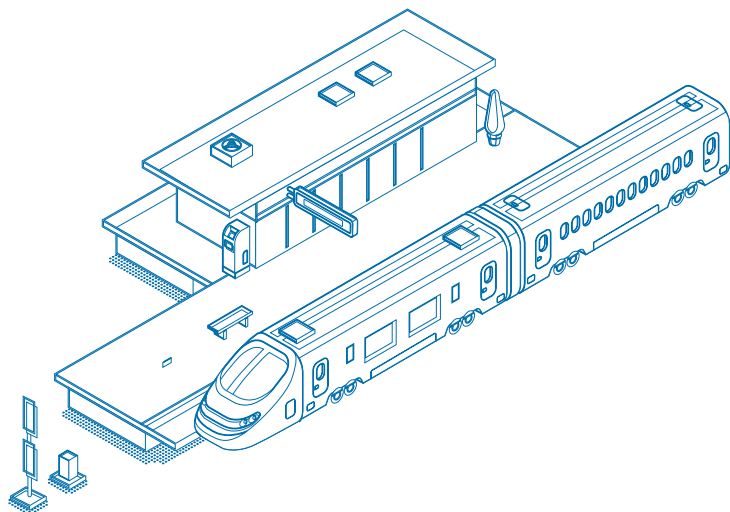

The railway junction of **Cherkasy** ensures a possibility of transport links with almost all the regional centers of Ukraine



The railway line passes through **Cherkasy**, on which the passenger and freight railway stations of Odessa railway of JSC «Ukrzaliznytsia» are located, providing for domestic, international and commuter trains.

The railway system in the city is in good condition, - the railways have been reconstructed, which ensured the higher speed train movement in the direction of Kyiv-Cherkasy- Kyiv.

The passenger terminal of the city is the railway station «Cherkasy» (founded in 1863) with a throughput capacity of 3 ths passengers a day. The freight terminal is a railway station «Cherkasy» (founded in 1876).

At a distance of 30 km from **Cherkasy**, in Smila town, there is a large railway junction, – the station named after T. G. Shevchenko.

Five city bus stations serve passengers of both interregional and international connections. There are bus connections with settlements of Cherkasy region, regional centers of Ukraine and cities abroad.

Inter-city connection

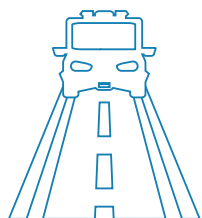

Cherkasy is located at the intersection of automobile routes, which have an access to such international highways



E 50

**Automobile route E 50
(international importance)**

France- Germany – Czech Republic–
Slovakia – Ukraine



E 95

**Automobile route E 95
(international importance)**

Turkey - Ukraine



P 10

**Automobile route P 10
(regional importance)**

Kaniv - Moshny - Cherkasy - Chervona
Sloboda - Les'ki -Krasnosillya-Kremenchuk



H 16

**Automobile route H 16
(national importance)**

Zolotonosha - Cherkasy - Smila - Shpola -
Zvenigorodka - Tal'ne - Uman

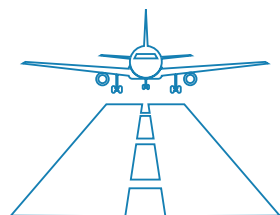

The runway of «Cherkasy» airport is among leaders for its ability to accommodate different types of aircraft

«Cherkasy» airport has a status of an international airport, but it is mainly used for domestic flights. The airport can accommodate any type of aircraft, from passenger planes to cargo aircraft weighing up to 190 tons. The airport is equipped for handling customs, border and quarantine procedures.

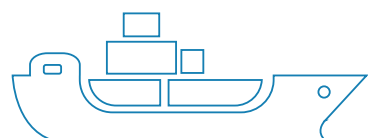

The functioning river-boat station and river cargo port allow to carry out the sale of products by river transport

The river cargo port is located in the middle flow of the Dnipro river at a distance of 725 km from the mouth of the river. The navigation takes place from April 15 to November 15. The port can accommodate self-propelled cargo hold ships of the «river-sea» type and river ships of a carrying capacity of 3 ths tons and up to 2 ths tons, respectively. The 128 m long berth is designed to accommodate 3 ships.

Public transport

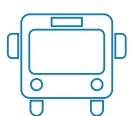

~ 16 mln pass.

annually transported
by buses

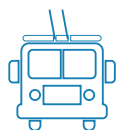

~ 11 mln pass.

annually transported
by trolleybuses



Public transport - automobile transport,
trolleybus



> 27 mln annually transported passengers



36 transport routes of public transport



806.7 km - length of routes



270.1 km - length of paved roads



395 public transport stops



339 buses and trolleybuses leave for routes
daily



>30% transportation is carried out by a
utility company «Cherkasyelectrotrans»

The City Council approved «The concept of the city passenger transport development in Cherkasy city» which outlines the problems and perspective ways of municipal transport development.

The concept envisages a series of steps aimed at improving the state of transport operations in the city. In particular, for better management, it is envisaged to integrate the GPS system into all the rolling stock of the public transport and to introduce an automated system of dispatching, accounting for and control over the movement of the public transport.

In order to ensure transparent regulation of tariffs, a non-cash payment system for travelling in the municipal public transit and an electronic passenger accounting system are envisaged to be introduced. There is a review of standards of stops and placement of electronic scoreboards with information on timetables. The Concept pays particular attention to the transport accessibility, in particular, its mobility.

The main problems of the municipal passenger transportation system are:

- imperfections in the existing route network of passenger transport;
- lack of positive dynamics of increasing the number of buses of medium and large capacity ;
- insufficient renewal of the rolling stock of electric transport;
- need to improve the tariff policy in the area of passenger transportation;
- lack of modern means of control over the operation of the city passenger transport.

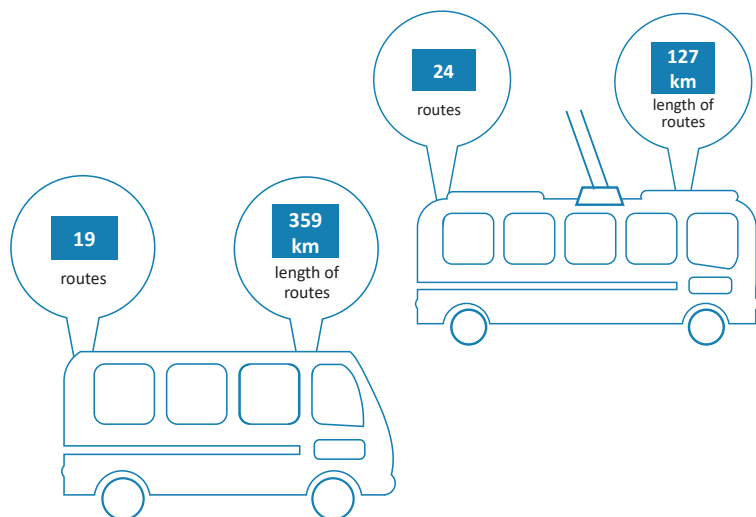



Key sectors of the economy

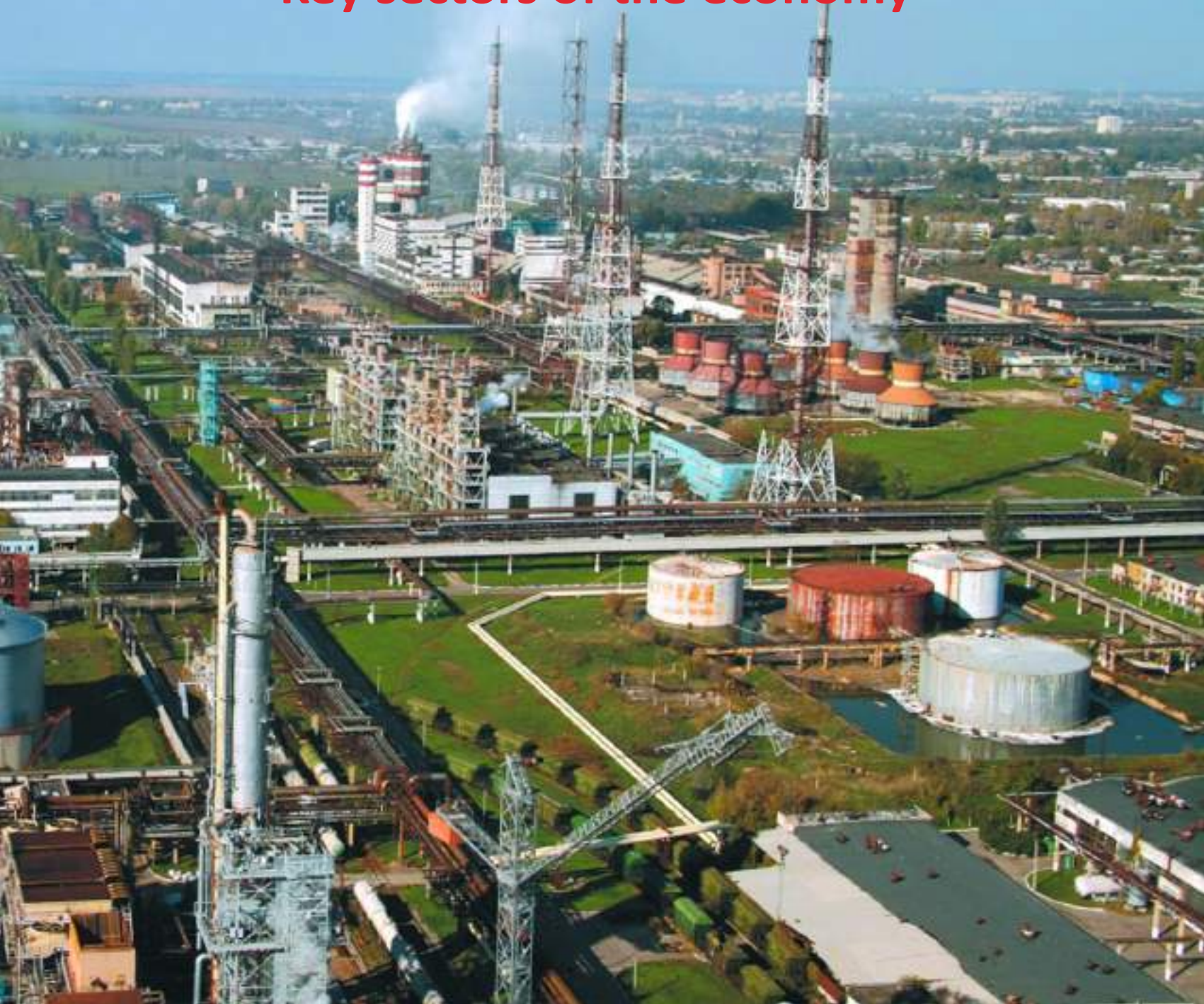

Economic potential

There is a diverse economy in **Cherkasy**, involving enterprises of different industries, including those which are of strategic importance for the national economy, construction, transport and trade enterprises, educational institutions and bodies of the city authorities, regional government, etc.

Cherkasy forms a significant share of the economy of Cherkasy oblast', which is in the TOP-10 regions of Ukraine by the level of gross regional product.

Gross regional product in 2021

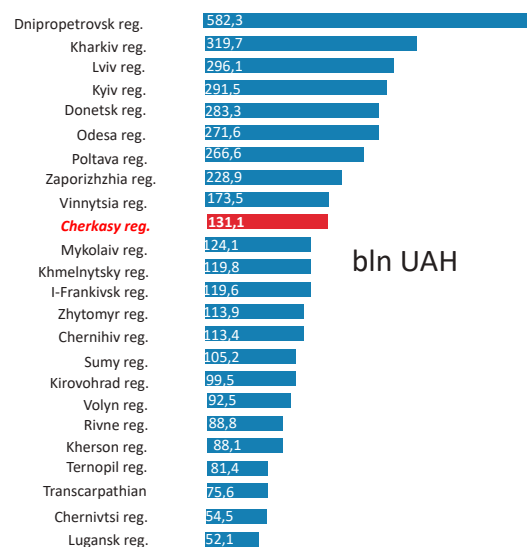

Cherkasy share in the economy of Cherkasy region

Indicator	Unit	Cherkasy region	Cherkasy share
Number of population	ths ppl	1160.7	23.2%
Average monthly wage	UAH	12952	103.6%
Volume of industrial output sold	mIn UAH	93471.7	39.6%
Exports of goods	mIn \$	883.4	28.4%
Import of goods	mIn \$	1053.6	73.0%
FDI	mIn \$	357.1	28.7%
Capital investments	mIn UAH	9590.2	47.5%
Completed construction works	mIn UAH	3628.1	37.7%
Commissioning of housing	m ²	175290	53.3%
Provision of services	mIn UAH	9610.2	51.6%
Retail turnover	mIn UAH	21061.6	57.7%
Passenger turnover	mIn pass km	1548.3	13.9%
Cargo turnover	mIn tons km	9807.7	8.0%
Financial result of enterprises before tax, 2020	mIn UAH	11165.5	29.0%

Number of enterprises, share by size

Year	Total	Large	Medium	Small
2018	4339	0,1%	3,6%	96,3%
2019	4640	0,1%	3,8%	96,1%
2020	4596	0,1%	4,0%	95,9%
2021	4596	0,1%	4,0%	95,9%

Volume of sales of goods and services, mIn UAH

Year	Total	Large	Medium	Small
2017	59164.6	20.3%	49.6%	30.1%
2018	65673.2	22.9%	43.6%	33.5%
2019	85621.6	14.6%	57.7%	27.7%
2020	105896.8	14.6%	58.9%	26.5%

Industry

Cherkasy has a significant industrial potential and wide opportunities for the development of both domestic inter-regional and foreign inter-state ties.

The status of **Cherkasy** as an industrial city results in a high indicator of the industrial output sold per capita, which exceeds Ukraine's average indicator.

Volume of industrial output per capita

Indicator, ths UAH	2019	2020	2021
Cherkasy region	61.5	64.6	80.5
Ukraine	59.2	59.6	87.1
Cherkasy	97.8	97.6	127.1

The city's economy has an industrial character. The basis of the industry is formed by chemical, woodworking, food and machine building enterprises.

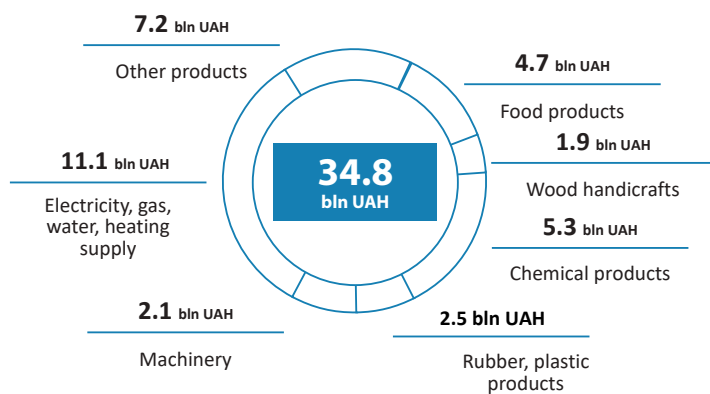

Structure of industrial output sold by major branches

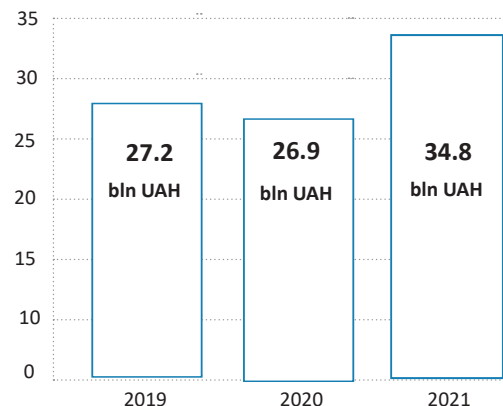

Industrial output sold

The city's industrial complex output is sold both inside the country and exported.

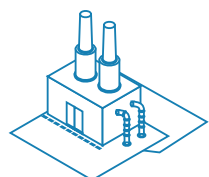

1%
share of city industry
in the structure of
the country



> 4 ths
enterprises of
different profiles

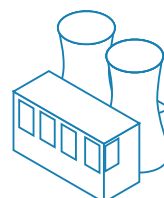

> 120
industrial
enterprises



~ 16 ths
individual
entrepreneurs

Chemical Industry

Indicator, bln UAH	2019	2020	2021
Volume of sales	5.7	4.6	5.3



mineral fertilizers

5.0%

share of enterprises of the branch in the market of Ukraine



remedies plants

15.2% industry share in the city's industry



varnishes and paints

5.3 bln UAH

industrial output sold in 2021



chemical reagents for various purposes

> 5.0 ths

specialists working in the chemical industry



AZOT

It is the largest enterprise of the city and one of the leading enterprises in Ukraine. It was founded in 1964 and is a part of the national Holding Ostchem Holding Limited. It manufactures chemical products, including ammonia and ammonia products, urea and other mineral fertilizers, which are sold both in Ukraine and abroad. The main consumers are agricultural producers.

azot.ck.ua

(047) 239-29-26



PAINT AND VARNISH PLANT «KANSAI Helios Ukraine»

The plant forms part of the corporation «Helios Group» (Slovenia), - one of the largest manufacturers of paint and varnish products in Europe. The complete reconstruction of workshops and production units, modernization of production with the introduction of modern technologies and high-efficiency equipment has been carried out at the enterprise.

kansai-helios.ua

(047) 271-28-81



CHEMICAL ELEMENTS UKRAINE

In 2016, a chemical reagent plant – «CHEMICAL ELEMENTS UKRAINE» LLC started operating in Cherkasy. Production capacity – up to 3 ths tons of products per year. Total cost of the project is EUR 1.5 mln. About 70% of the enterprise's products are exported.

chemelements.de

(047) 259-02-28



UKRAVIT SCIENCE PARK

It is a part of the corporation «UKRAVIT» and is a leading manufacturer of plant protection products and highly concentrated complex liquid fertilizers. In 2018, the opening of the Scientific-Research Institute of the Plant Health was held at the enterprise. Functionally, this institute combines fundamental and industry research, agrobiological service, educational and scientific work. This is the newest scientific and research institute that has no analogues in Ukraine and in the neighbouring countries.

ukravit.ua

(044) 494-38-26

Machinery

Indicator, mln UAH	2019	2020	2021
Volume of sales	2752.2	1362.2	2075.0



buses

39%
share of JSC Cherkasy
Bus in the market of
bus production in
Ukraine



commercial and
special vehicles,

6%
industry share in the
city's industry



household appliances

+52%
growth rate
to 2020



machinery for agriculture

in **2021**,
**303 buses and 35
trucks** were
produced in Cherkasy



SIC SCANNER

The company specializes in the development, production, supply, warranty and post-warranty maintenance of complex medical equipment - colposcopes, surgical microscopes, forehead surgical magnifiers, electrosurgical high-frequency devices, medical video systems and special software.

scanner.ua

(047) 255-27-35



CHERKASY BUS

It is a leading bus manufacturing company. Here, since 1993 about 17 ths buses of different models and modifications, trucks have been manufactured. In 2018, 441 buses and 47 trucks were manufactured. Buses meet environmental requirements by the emission level of EURO-5 and above. The company owns «ATAMAN» trademark, which is used for all products of the enterprise.

bus.ck.ua

(047) 264-43-14



LLC PRODMASH

LLC PRODMASH — is a machine-building enterprise with many years of experience in production of equipment for food and processing industries and consumer goods.

[http://prodmash.org.ua/](http://prodmash.org.ua)

(063) 662-17-84



CHERKASYELEVFORMASH

Since 1967, it has been manufacturing equipment for transportation, processing, drying of grain and grain products. The enterprise serially produces for compound feed industry extruders for the production of full-fat soybeans, grain extrudates, compound feeds for animals. In 2021, forklifts, extruders and pneumatic conveyors to the amount of 204.9 mln UAH were manufactured.

bronto.ub.ua

(047) 250-09-34

Food industry

Indicator, mln UAH	2019	2020	2021
Volume of sales	3125.1	3442.8	4722.3



dairy products

1%

share of enterprises of the branch in the market of Ukraine



sweets and confectionery

13.5% industry

share in the city's industry



bakery

4.7 bln UAH

industrial output sold in 2021



frozen vegetables and berries



products from corn

+37.2%

growth rate to 2020



YURIYA

The company produces and markets dairy products and butter under TM «Voloshkove pole». The assortment consists of more than 100 product lines. The production capacity of the enterprise allows to process more than 200 tons of dairy raw materials per day and to ship more than 100 tons of dairy products daily to the trade networks of Ukraine.

voloshkovepole.com.ua

(047) 271-61-92



SVIT LASOSCHIV

It is part of a group of companies «PetRus» and manufactures sweets and confectionery under TM «Domashnie sviato» and TM «Perepilka». TM «Domashnie sviato» is among the TOP-10 national brands of flour confectionery. The production is carried out on the equipment of the leading world brands, the capacity exceeding 4 ths tons of products per month.

dssweets.com.ua

(047) 271-02-29



CHERKASYKHLIB

The company produces 270 items of bakery and confectionery products. The average monthly production volume amounts to 4.5 ths tons. The company's products are sold through its own trading network «Formula Smaku», which includes 25 trade pavilions in Cherkasy and 7 trade pavilions in the region. In recent years, about 30 types of enterprise's products have received awards at regional and national exhibitions and competitions.

formula-smaku.com

(047) 271-01-20



FRAU MARTA

It is the largest producer of frozen vegetables and berries in Ukraine. It was created in 2003 with attraction of foreign investments. The production is carried out on modern European equipment for freezing of vegetable products. The production cycle includes all the technological steps of manufacturing the final product: cultivation, sowing, cultivation, harvesting, processing and freezing.

fraumarta.com.ua

(047) 263-45-53



ALTERA AZTEC MILLING UKRAINE

It forms part of the group of companies «Gruma» (Mexico), - the world's leader in the production of corn flour and corn products. The plant is a major producer of corn grits and corn flour in Ukraine.

alteragrama.com

(047) 271-15-59

Light industry

Indicator, mln UAH	2019	2020	2021
Volume of sales	571.5	793.2	699.6



shoes

1.0%

share of enterprises of the branch in the market of Ukraine



fabric

2.0%

industry share in the city's industry



clothing

0.7 bln UAH

industrial output sold in 2021



sun protection systems

+1%

growth rate of fabric production to 2021



MANEZH

It produces modern exterior and interior window sun protection systems. It has 19 year-experience in manufacturing sunscreen systems. The ISO 9001 quality management system is in place, the LEAN system «TOYOTA DAO» for economical production is being implemented, high-tech equipment is used.

manezh.ua

(050) 447-50-99



CHERKASY SILK PLANT

It is one of the largest light industry enterprises in the country; it was built in 1967. It manufactures fabrics from chemical fibers and threads, mixed (unmixed), synthetic, artificial and natural fibers.

silkck.alexlans.com

(047) 264-53-33



ViVa-trade

ViVa-trade is a leading company of work clothing, work shoes and personal protective equipment production and delivery. Company has been working at the market of production and sales of personal protective equipment for more than ten years.

oxran.com/

(099) 440-01-66



SHOE FACTORY «LAVENTA»

The company was created in 1997 and specializes in the production of genuine leather footwear under TM «Laventa».

shoes.ck.ua

(047) 263-69-31



FACTORY «LESYA UKRAINKA»

The company has been operating since 1971 and is a manufacturer of exclusive women's clothing under its own brand name LESIA.

opt.lesya.ck.ua

(047) 232-49-83

Another industries



thermal and water-proofing insulation



gauze and cotton wool



pharmaceutical goods



plastic products



metal products



packaging



TECHNO

Heat insulating materials factory became operational in 2009, being the first in the country to produce non-combustible thermal insulation for the construction industry on the basis of stone wool. An amount of € 16 mln was invested in the creation of the plant.

 ua.sweetondale.cz

 (047) 271-97-90



YUJIN LTD

The company was established in 1992 and specializes in processing of plastics and marketing of plastic products. Production facilities are 2.2 ths m², warehouse facilities are 1.3 ths m², plastic molding capacity - 12 automatic thermal injection machines.

 www.yujin.com.ua

 (047) 235-43-35



YURIA FARM

The pharmaceutical company is a leader in the infusion drug market in Ukraine and is among the TOP-10 pharmaceutical manufacturers. Product sales have a broad geography. The annual output is about 7 mln pieces. About 15 new drugs are put into production annually.

 uf.ua

 (044) 246-83-83



VATFARM

The company is a leading manufacturer of cotton-gauze medical products, which is manufactured by the brand «Malva». It is the only manufacturer of medical cotton wool in the country by European quality standards, consumer properties, appearance and reliability of packaging.

 vatfarm.com.ua

 (047) 264-00-77



METAL-INVEST

It has been engaged in production of hot dip galvanizing since 2012. The production area covers 5 000 m², the volume of investments exceeded 100 mln UAH.

 metalinvest.ua

 (047) 259-98-50



MM PACKAGING UKRAINE

The cardboard packaging plant, which forms part of one of the world's leading cardboard production leaders, - concern MM Group (Austria), opened in 2008. More than € 15 mln was invested in the creation of new facilities.

 mmp-ukraina.com

 (047) 254-59-01

Supply of energy and water, drainage system

Indicator, mln UAH	2019	2020	2021
Volume of sales	7971.3	8566.0	11823



water supply and drainage



supply of electricity



supply of heat and hot water



gas supply



CHERKASYVODOKANAL

The public utility company providing centralized water supply and sewerage services is the owner of water supply and sewerage networks, facilities of the city. Every day the company sells up to 80 ths m³ of drinking water, servicing the area of 7.8 ths ha, the number of subscribers amounts to 229 ths.

 vodokanal.ck.ua

 (047) 237-33-00



CHERKASYPLOCOMUNENERGO

It is a public utility company which produces, supplies, sells and distributes thermal and electric energy, repairs and reconstructs buildings and facilities of boiler houses, central thermal points of thermal networks. The company is the operator of 166 km of heat networks, 109 individual heat points, 82 central heat points, 36 boiler rooms of 541 Gcal/h capacity, 4 cogeneration plants of 5.3 MWh/h capacity.

 tke.ck.ua

 (047) 254-06-92



CHERKASYOBLENERGO

It is engaged in transmission and supply of electric energy, serves 631.5 ths consumers, operates 39 transformer substations of voltage 110 - 154 kV, 136 substations of 35 kV voltage, the total capacity of transformer substations of 35-154 kV voltage amounts to 2326.9 MVA. 8885 transformer substations and switchgears with a voltage of 6-35 / 0,4 kV are also in operation, with a total capacity of 1698.8 MVA.

 cherkasyoblenergo.com

 (047) 236-02-69



CHERKASYGAZ

It is engaged in supplies natural and liquefied gas, operation of gas supply systems, gasification of facilities, as well as other types of production, commercial and financial activities. The company is the operator of more than 13 ths km of gas networks, with over 440 ths subscribers.

 chergas.ck.ua

 (047) 271-27-00

Construction

Indicator	2019	2020	2021
Commissioning of housing, ths m ²	70.7	15.9	93.4
Completed construction works, mln UAH	1075.3	1097.9	1367.8



industrial
construction

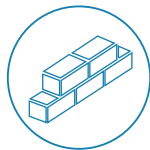

commercial
construction



housing



supply of building
materials



GROUP OF COMPANIES «DOBROBUD»

One of the largest construction enterprises in the city specializing in the construction of housing, retail, office and industrial premises. The enterprise has strong industrial production facilities which allows for a closed production cycle, including production and supply of materials.

 dobrobud-sale.com

 (047) 231-33-55



NADIYA

The enterprise is engaged in residential and industrial construction. Over the period of its existence, 11 multi-storey buildings and more than 30 industrial facilities have been built. Its construction facilities cover an area of 82.0 ths m². The enterprise has a concrete plant of capacity 200 m³/per shift, which allows to reduce the cost of construction and to offer optimal solutions of the tasks.

 nadiyabud.com

 (047) 254-41-03



PBK-AGROPROEKT

The enterprise implements projects in the market of design and survey and construction works on facilities of agricultural, industrial and civil purpose. It is a part of the production group consisting of five companies which provide logistics, construction equipment and labor force. Over the period of its existence, 12 projects of national importance have been implemented.

 agroproekt.com

 (067) 472 16 38





Logistics and trade



Logistics and business infrastructure

Industrial and trade development in **Cherkasy** takes place in adequate technical and infrastructural capabilities.

Cherkasy has considerable prospects for creating a logistics hub of the central Ukraine, which is contributed by location of the city in the central part, close to international transport routes.

City / border crossing point	Distance from Cherkasy	
Airport «Boryspil»	160 km	99.4 ml
Kyiv	189 km	117.4 ml
Kharkiv	371 km	230.5 ml
Odesa (seaport)	445 km	276.5 ml
Berlin	1 526 km	948.2 ml
Warsaw	966 km	600.2 ml
border point with Poland	692 km	429.9 ml
border point with Slovakia	998 km	620.1 ml
border point with Hungary	1 000 km	621.3 ml
border point with Romania	1 030 km	640.0 ml
border point with Russia	662 km	411.3 ml
border point with Belarus	406 km	252.2 ml
border point with Moldova	405 km	251.6 ml

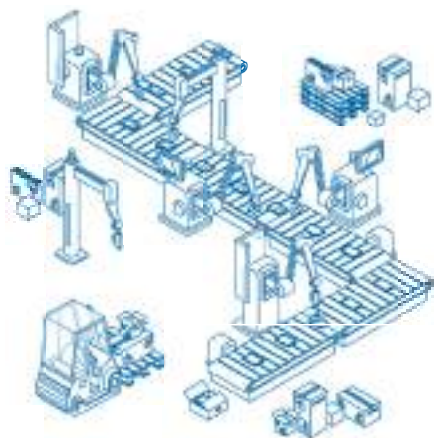

The market of commercial and office real estate is intensively developing.

In recent years, 11 office centers and shopping malls of the total area exceeding 141 ths m² have been built and commissioned in **Cherkasy**.

Name of the mall	Address	Area, m ²
«Grand Market»	Gagarin st., 55/1	2 220
«Plazma»	Shevchenko boulevard, 145	9 000
«City center»	Smilyansk-Blagovestna st.	11 400
«Epicentre»	30 th Anniversary of Victory st., 29	19 715
«Dnipro-Plaza»	Portovaya st., 34	17 745
«Khreschatyk City»	Dashkovich st., 19	23 000
«Lubava City»	Shevchenko boulevard, 207/1	25 721
«Green City»	Sumgaitkaya st., 8	8 420
«Depot»	Shevchenko boulevard, 385	19 407
«PIONEER»	Shevchenko boulevard, 274	857
«RYNKOVYY»	Smilyanska st., 45	3 554

For conferences, seminars, trainings, presentations, meetings, business meetings and cultural events, a number of city hotels offer comfortable conference rooms equipped with modern facilities.

Name of the hotel	Address	Number of rooms	Conference-room
Cherkasy Palace	V. Gorova st, 145	65	2 halls for 30-100 pl
Dnipro	V. Gorova st, 13	73	1 hal for 70 pl
Ukraine	Lisova st., 1	91	4 halls for 20-120 pl
Optima Cherkasy	Lasareva st., 6	79	2 halls for 90 pl
Nyva	Smilyanska st., 144	60	1 hall
Selena	Dakhnivska st., 21B	42	1 hall

Trade and services

Cherkasy is well-provided with trade and catering facilities, as well as communal services providers.

The level of provision of the population with retail trade space is high.

Retail turnover per capita

Indicator, ths UAH	2019	2020	2021
Cherkasy region	12.7	13.9	18.1
Ukraine	26.1	29.1	35.1
Cherkasy	31.2	35.2	44.6

The retail network is represented by such leading networks as: «Velyka Kyshenya», «ATB-market», «Silpo», "Faino Market", "Delvi", «Premier Plaza», «Delikat», «MoLLi», «Epicentr», «Foxtrot», «Comfy», «Allo», «FoxMart», «Technopolis», «Eldorado».



242

grocery stores



24.1 ths m²

area of grocery stores, warehouses



603

non-food stores



17.7 ths m²

area of non-food stores



406

kiosks and pavilions



9.5 ths m²

area of kiosks and pavilions



160

pharmacy and pharmacy items



7.9 ths m²

area of pharmacy and pharmacy items

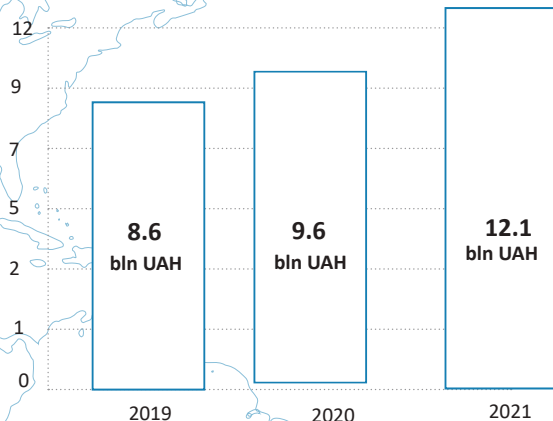

Retail turnover



Number



Seats

Restaurants and bars	66	4.4 ths
Cafes, cafeterias	178	9.8 ths
Snack bars, buffets	12	0.4 ths
Canteens	21	1.3 ths

Foreign trade

The geography of exports and imports of goods and services, which are carried out by enterprises of **Cherkasy**, is annually expanding.

The foreign trade structure is diversified both by product groups and by countries.

Foreign trade

Indicator	2020	2021	2022
Exports of goods & services	\$ 194.0	\$ 250.9	\$ 299.2
Imports of goods & services	\$ 493.0	\$ 769.1	\$ 318.2
Foreign trade turnover	\$ 687.0	\$ 1019.2	\$ 617.4
Trade balance	\$ (-)299.0	\$ (-)518.2	\$ (-)19.0
Number of partner countries	110	122	119

The main groups of goods for export



products of vegetable origin



chemical products



wood products



machines & equipment

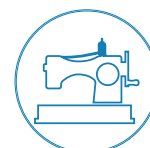

textiles



food products

The main groups of goods for import



oil and fuel



chemical products



plastics and polymers



machines & equipment



paper and cardboard



transport

Exports	Oman	Poland	Romania	China	Belarus	Libya	Germany	Netherlands
2020	\$ 9,0 mln	\$ 13,4 mln	\$ 9,9 mln	\$ 5,4 mln	\$ 23,9 mln	\$ 3,9 mln	\$ 14,1 mln	\$ 4,5 mln
2021	\$ 30,7 mln	\$ 28,1 mln	\$ 18,0 mln	\$ 16,1 mln	\$ 14,4 mln	\$ 13,8 mln	\$ 11,4 mln	\$ 8,5 mln

Imports	Switzerland	China	Poland	Germany	Turkey	Austria	Belarus	Kazakhstan
2020	\$ 74,7 mln	\$ 40,5 mln	\$ 41,1 mln	\$ 24,5 mln	\$ 15,3 mln	\$ 2,2 mln	\$ 14,7 mln	\$ 6,4 mln
2021	\$ 376,9 mln	\$ 59,9 mln	\$ 57,2 mln	\$ 34,0 mln	\$ 30,1 mln	\$ 18,7 mln	\$ 18,2 mln	\$ 12,1 mln



Investment and international cooperation



Investment policy

In order to facilitate the attraction of investments, **Cherkasy city authorities** are on an on-going basis implementing measures to improve the investment climate, the management quality and the administrative services provision.

The city authorities of **Cherkasy** contribute to the development of land relations, create organizational and economic conditions for the lawful and efficient use of land and real estate property, as well as to attract investments in the city construction development.

Type of land	ths ha
Land in lease	3.2
Land of citizens	1.5
Land of industry	1.2
Land of institutions	1.2
Other land	0.7
Area of Cherkasy e	7.8

6.0 ths ha



land under construction

0.1 ths ha

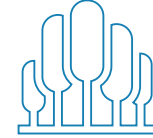

land under forests

1.6 ths ha



agricultural land

0.1 ths ha



land under water

Promotion of the city's potential. Formation of an investment-attractive image of the city as an area favourable for investment, co-operation and leisure.

Creating favourable conditions for starting new and developing existing enterprises, increasing their competitiveness.

Stimulation of entrepreneurial activity in order to reduce social tensions, first of all, through self-employment of the population.

Facilitating business entities in promoting their own products and services.

Overcoming administrative barriers on the way of entrepreneurship development.

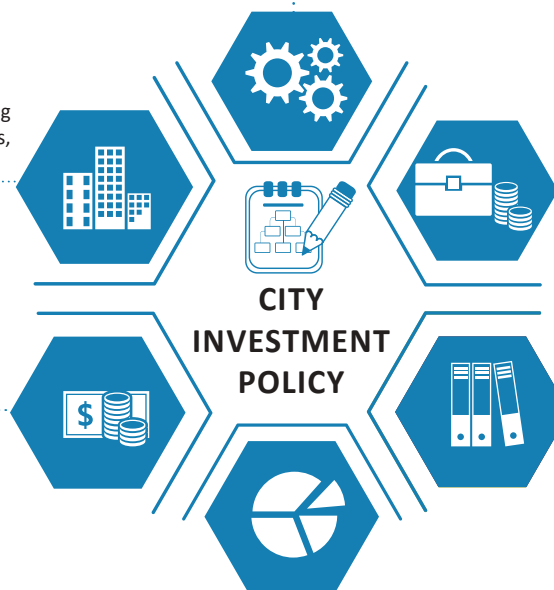

**CITY
INVESTMENT
POLICY**



High investment attractiveness in "IBI-Rating" ratings

To inform the society and the business community about the city development, **Cherkasy City Council** maintains the rating of investment attractiveness of the city.

Improvement and development of the system of entrepreneurship support in the city. Providing organizational, informational and consulting support to business entities.

Investments

Cherkasy has a sufficiently developed industrial complex and potential for preparing attractive proposals for investors.

The city can develop its own industries such as chemical, food, light, machine building, construction, transport industries and logistics, where funds of investors have already been attracted.

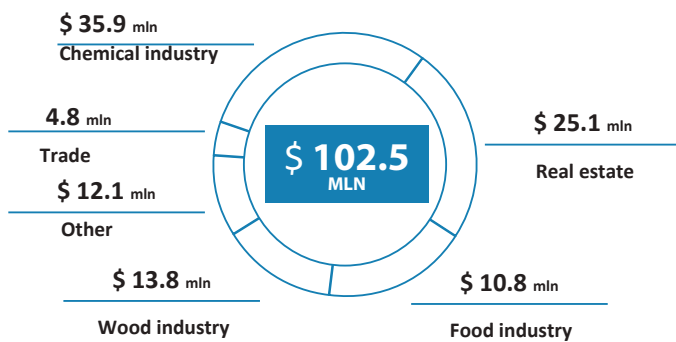

Structure FDI by industries



Cyprus



Czech Republic



Germany

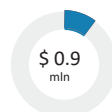

Great Britain



Slovenia



the Netherlands

Capital investments and FDI

Indicator	2018	2019	2020
Capital investments	2348.1 mln UAH	2584.1 mln UAH	3053.1 mln UAH
FDI	\$ 106.1 mln	\$ 105.1 mln	\$ 102.5 mln

The policy of the city authorities is aimed at creating a favorable institutional and economic environment for attracting capital.

FDIs from 30 countries have been attracted to 110 enterprises of **Cherkasy**.

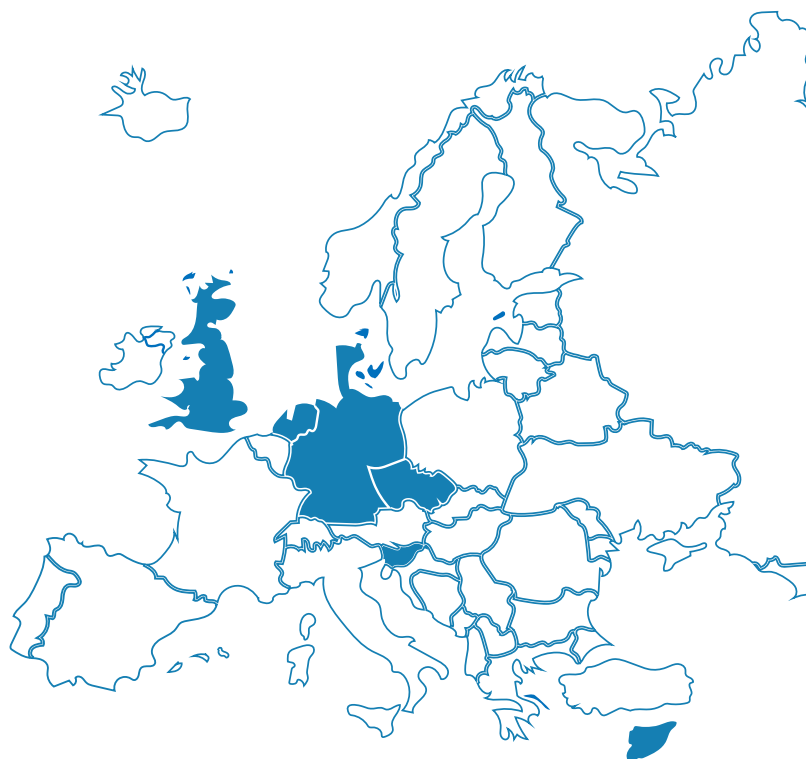







International cooperation

Priorities of **Cherkasy** authorities are the standards and principles which the Council of Europe and the European Union are guided by. In recent years, a number of projects have been implemented in the city involving international

Cherkasy received recognition from the Parliamentary Assembly of the Council of Europe for developing and spreading ideas of the European unity and cooperation: the European Diploma (2013) and the Flag of Honour (2016).



	<p>In 2012 Cherkasy joined the Covenant of Mayors, – the leading initiative of the European Union. A commitment to reduce its own CO₂ emissions at least by 20% by 2020 has been taken. In the framework of implementation of the Covenant of Mayors, an «Action Plan for the Sustainable Energy Development of the City of Cherkasy until 2020» was developed.</p>		
	<p>Project «Development of the city's infrastructure». Modernization of the water supply and sewage pumping stations of CE «Cherkasyvodokanal» has been carried out with the introduction of energy-saving technologies. The energy consumption by the pumping stations has been reduced: for the water supply to 24%, for the sewage to 30%, respectively.</p>	2009-2014	\$ 10.9 mln
	<p>Project «Reconstruction of the water drainage networks, introduction of an automated control system and construction of wastewater treatment facilities at the Dnipro water treatment plant» (under implementation).</p>	since 2016	\$ 12.3 mln
	<p>Project «Modernization of the heat supply system». A biofuel boiler and 109 individual heating points in residential buildings have been installed, the re-equipment of three boiler-houses with installation of co-generation units has been carried out, 10.3 km of the heat networks have been replaced. Gas savings have been achieved, losses of the heat networks, the consumption of the thermal energy in residential buildings have been reduced.</p>	2008-2014	€ 11.2 mln
	<p>Project «Energy efficiency of public buildings of the budget institutions». Thermo-modernization of premises of 3 secondary schools. Energy audit of 34 secondary schools has been conducted and a list of energy-efficient measures, which are the most expedient for implementation, has been submitted for consideration.</p>	2015-2018	€ 0.9 mln
	<p>Project «Optimization of Cherkasy Municipal Energy Network Modernization Strategy and Organization of Decentralized French-Ukrainian Energy Co-operation». It was implemented in the framework of the memorandum signed between the French Embassy and Cherkasy City Council.</p>	2015-2016	€ 0.07 mln
	<p>Project «Research into modernization of the waste management system in Cherkasy». As a result of the project, BETEN INGENIERIE company presented a feasibility study, business plan and financing options for the implementation of a modernized waste management complex in the city.</p>	2016-2017	€ 0.5 mln

Cooperation agreements have been signed between **Cherkasy** and 12 cities in different countries of the world and friendly partnerships have been established.





BUDGET CAPACITY



Budget and solvency

Growth of business activity allows *Cherkasy* to increase the budget revenues, provide for a more flexible local budget expenditure policy and increase expenditures on the development of the city's infrastructure.

The filling up of the budget is differentiated both by industry and by payers of taxes and fees.

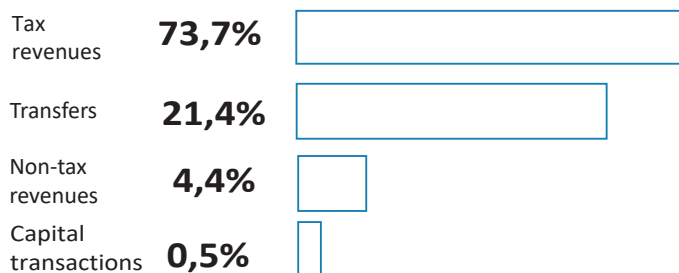

Since 2013 the credit rating has been maintained, which indicates that *Cherkasy* has sufficient creditworthiness

IBIRATING Certified National Rating Agency

	Credit Rating	Outlook
2019	uaBBB	Stable
2020	uaBBB	Stable
2021	uaA-	Stable
2023	uaA-	Evolving

uaBBB - the sufficient creditworthiness as compared to other Ukrainian obligors.

uaA- High creditworthiness compared to other Ukrainian borrowers

Indicator, UAH	2019	2020	2021
Budget revenues, mln	3103.8	2708.3	3285.2
Budget expenditures, mln	3117.5	2721.0	3180.1
Own budget revenues per capita in Cherkasy	7365.4	7919.3	9170.1
Own budget revenues per capita in Ukraine	7143.6	7457.2	7457.2

Cherkasy city council together with utility companies are participants in the external borrowing market.

Funds are attracted from international financial institutions to implement infrastructure projects.



\$ 10.9 mln

Project «Modernization of the water supply and sewage pumping stations».



\$ 12.3 mln

Project «Reconstruction of the water drainage networks, introduction of an automated control system and construction of wastewater treatment facilities at the Dnipro water treatment plant».



€ 9.4 mln

Project of «Modernization of the heat supply system».



9.1 mln UAH

Project «Energy efficiency of public buildings of the budget institutions».

Borrowing obligations are executed in full scope according to concluded agreements.

The indicator of debt burden on the city budget revenues net of transfers is acceptable.

WELCOME FOR COOPERATION

Department of economy and development of Cherkasy City Council

Baydi Vishnevetskogo St., 36
Cherkasy city, Ukraine, 18000
tel. / fax: +38 0472-33-19-80
e-mail: depec@ukr.net
<http://chmr.gov.ua>

